

HOLE PATTERN DIMENSIONS

3 1/2" HINGE HOLE PATTERNS

HR 3501

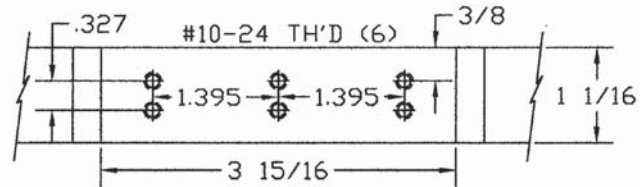

HR 3502

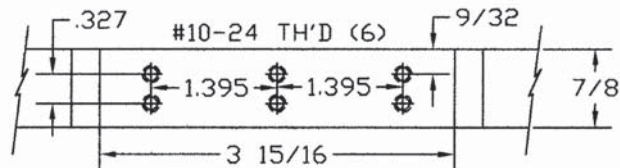

HR 3503

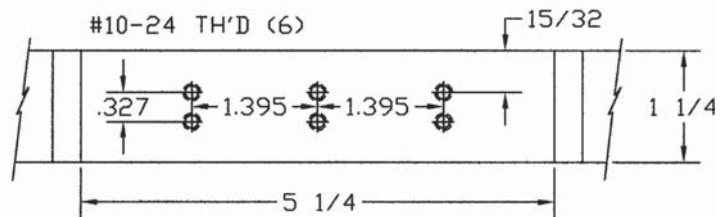

HR 3504

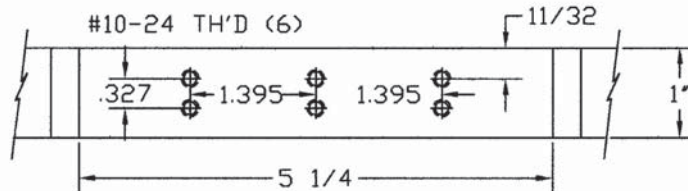

HR 3505

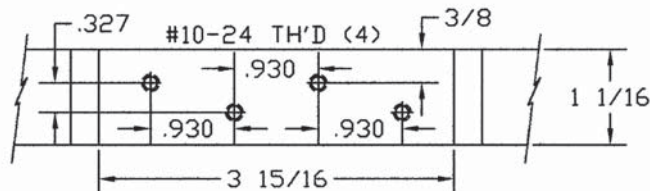

HR 3507

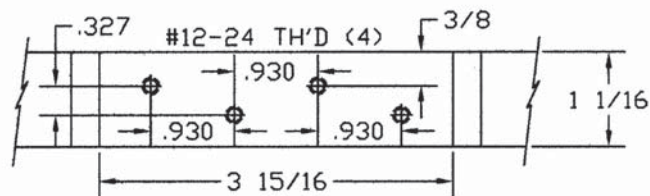

HR - ECONOMY

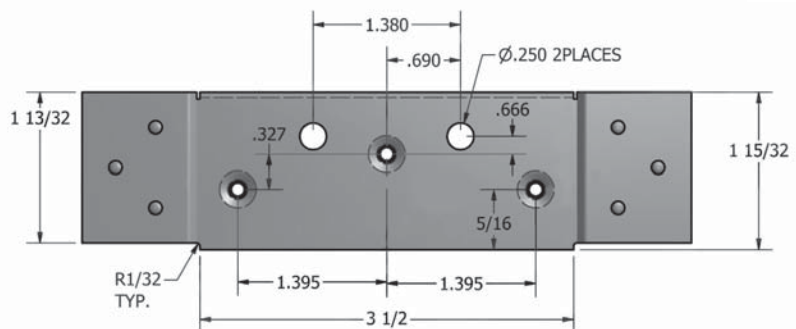

DAYTON INDUSTRIES, INC.

CATALOG NO. 0315

1350 GARRISON AVE., BRONX, NY 10474
(718) 542-8144 FAX:(800) 221-3932

PAGE 5