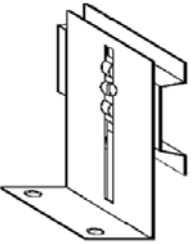
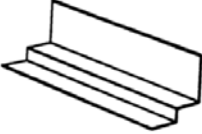
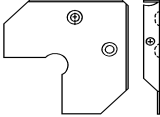
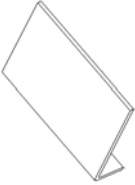
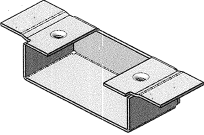

<p>ADJFL-16 E CTN</p> <p>Adjustable floor anchor</p> <p>Frame weld 3 1/4" x 4 1/4" Anchor 3 1/4" x 1 1/2" x 6 3/4" 16 gage EZ</p> <p>pkg of 20</p>	
--	---

<p>CRF-6</p> <p>Closer Reinforcement Frame 14 gage x 13 3/4" long 1 7/16"x5/8"x1 15/16"x1 9/16" Galvanneal</p> <p>pkg of 10</p>	
---	---

<p>CG-19F CTN</p> <p>DOOR FRAME GUSSET CRS #6 CSK, .116 DIA (2)</p> <p>pkg of 100</p>	
---	---

<p>CTWI-1 CTN</p> <p>Weld-In Corner Tab</p> <p>For standard 2" face frames</p> <p>5/8" x 7/16" x 1 7/8" 16 gage HRPO</p> <p>pkg of 50</p>	
---	---

<p>COMB-234 IDT CTN</p> <p>Combination Strike Reinforcement & Dust Cover</p> <p>2 3/4" 16 gage CRS or EZ</p> <p>pkg of 20</p>	
---	---

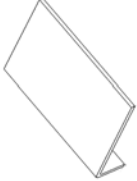
<p>CTWI-3 CTN</p> <p>Weld-In Corner Tab</p> <p>For 4" profile frames</p> <p>5/8" x 7/16" x 3 7/8" 16 gage HRPO</p> <p>pkg of 50</p>	
---	--

<p>COMB-478E CTN</p> <p>Combination Strike Reinforcement & Dust Cover for standard ASA or 4 7/8"</p> <p>4 7/8" 16 gage EZ</p> <p>pkg of 20</p>	
--	---

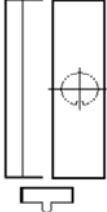
<p>DC-TAB CTN</p> <p>Mortar Box</p> <p>24 Gage EZ</p> <p>pkg of 36</p>	
--	---

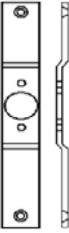
<p>CONV-86161 Z CTN</p> <p>86LA Latch Adaptor Zn Plated 86 lock edge to 161 latch 161 latch position is offset 3/16" (2) #12 CSK (2) 8-32 THD Two(2)#12-24 FHMS</p> <p>pkg of 10</p>	
---	---

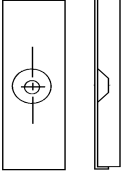
<p>DC-50 CTN</p> <p>DUST COVER</p> <p>26G CRS OR ELECTRO ZINC</p> <p>pkg of 50</p>	
---	---

<p>CONV-86-ASA Z CTN</p> <p>86 SA Strike Adaptor Zn Plated Two(2)#12-24FHMS 86 lock edge to ASA strike 3/32" offset 1 1/4" x 8" x 7 gage HRPO cutout 3/4" x 3 1/2" (2) # 12 CSK</p> <p>pkg of 10</p>	
---	---

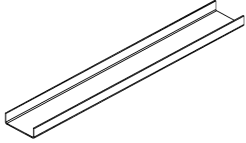
DOOR CH-3,-4,-8,-10	
Door Channel	
1/2" x 1 41/64" x 1/2"	
18 gage EZ	
50 pc bundle	

EMA-58 E CTN	
Adjustable Butterfly	
Existing wall anchor	
4 3/4" to 6 3/4" 17 gage EZ	
pkg of 100	

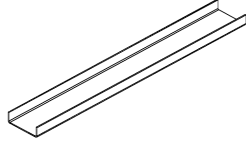
DOOR CH2-3,-4,-8,-10	
Door Channel	
7/8" x 1 41/64" x 7/8"	
18 gage EZ	
10 pc bundle	

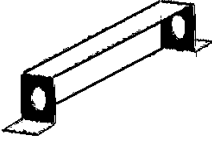
EMB-12	
ELECTRICAL MUD BOX	
12" X 1 5/8" X 1 3/4"	
EMB-7	
ELECTRICAL MUD BOX	
7" X 1 5/8" X 1 3/4"	
pkg of 5	

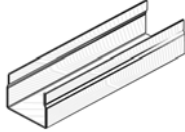
DOOR EDGE CHANNEL	
NO HOLES	
18GA GALV	
DOOR EDGE CH-10 (10 FT)	
DOOR EDGE CH-3 (3 FT)	
DOOR EDGE CH-7 (7 FT) DOOR EDGE CH-8 (8 FT)	
6 pc bundle min for 10' and 7' lengths	

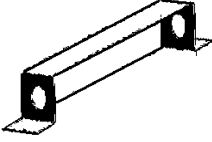
EMB-1438	
ELECTRICAL MUD BOX	
12" X 1 7/8" X 1 7/16"	
EMB-1750	
ELECTRICAL MUD BOX	
12" X 1 7/8" X 1 3/4"	
pkg of 5	

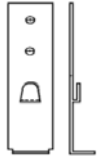
DSA-15 CTN	
DryWall Sill Anchor	
1 1/2" Trim, length = 3 1/2" Ref	
18 gage CRS	
pkg of 100	

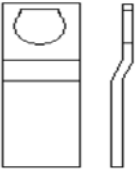
FB GUIDE C 1/2 DE	
FB GUIDE C 9/16 DE	
Flush Bolt Guide Tab-Zn Plated	
1 3/8 x 2 1/2 x 11GA EZ	
1/2" & 9/16" "D" Guide Hole	
FB GUIDE C 1/2 SQ E	
1 3/8 x 2 1/2 x 11GA EZ	
1/2 x 1/2 Square hole	
pkg of 50	

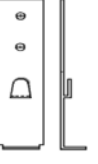
DSA-18 CTN	
DryWall Sill Anchor	
2" Trim, length = 4" ref	
18 gage CRS	
pkg of 100	

FB-ONEPC 12E CTN	
One piece reinforcement	
EZ	
1 3/8" x 11" x 14 gage	
pkg of 25	

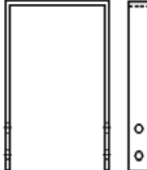
DSA-35 E CTN	
DryWall Sill Anchor	
Weld In	
3" x 3 1/2" 18 Gage EZ	
pkg of 100	

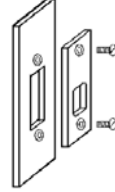
FB-REV CTN YCH	
Weld in Reversible	
Flush Bolt Strike & Reformem't	
Yellow Zn Chromate	
3 3/4" x 1 1/8" x 16 gage	
7" x 1 1/2" x 14 gage CRS	
8/32 X 3/8 flat head screws (2)	
pkg of 25	

DAYTON INDUSTRIES, INC.

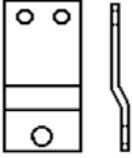
FB-01C832 094E12	
Flush Bolt Tab	
For 1" face flush bolts 3/32" offset 7/8" x 2 1/2" x 11 gage EZ (2) 8-32 THD	
pkg of 50	

FILP-21402 CTN YCH	
Strike Filler Plate	
1" x 2 1/4"x11 gage HRPO (2) # 8 CSK Zn Yellow Chromate or EZ Two (2) #8-32 FHMS	
pkg of 25	

FB-01C832 FLAE12	
Flush Bolt Tab	
Zn Plated For 1" face flush bolts No offset 7/8" x 2 1/2" x 11 gage EZ (2) 8-32 THD	
pkg of 50	

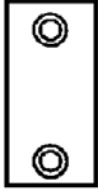
FILP-23403 CTN YCH	
Strike Filler Plate	
1 1/8" x 2 3/4" x 12 gage HRPO (2) # 8 CSK Zn Yellow Chromate or EZ Two (2) #8-32 FHMS	
pkg of 25	

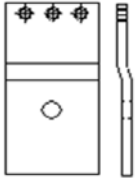
FB-08C10-24 188E	
Power Transfer Tab	
1 1/4" x 2 1/2" x 11 gage EZ Zinc Plate .188" offset (3) 10-24 THD	
pkg of 25	

FILP-47800 CTN YCH	
Strike Filler Plate	
Zn Yellow Chromate or EZ For ASA strike 1 1/4" x 4 7/8" x 13 gage HRPO (2) # 12 CSK Two (2) #12-24 FHMS	
pkg of 25	

FILP-23402 CTN YCH	
Strike Filler Plate	
For government 160 strike 1 1/8" x 2 3/4"x16 gage HRPO (2) # 8 CSK Zn Yellow Chromate or EZ Two (2) #8-32 FHMS	
pkg of 25	

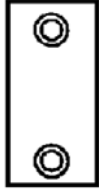
FILP-23404 CTN YCH	
160SFB Strike Filler Plate	
For Schlage B lock & others. 1 1/8" x 2 3/4" x 16 gage HRPO (2) # 8 CSK Zn Yellow Chromate or EZ Two (2) #8-32 FHMS	
pkg of 25	

FILP-21401 CTN YCH	
Door Edge Filler Plate	
For government 161 latch 1 1/8" x 2 1/4" x 11 gage HRPO (2) # 8 CSK Zn Yellow Chromate or EZ Two (2) #8-32 FHMS	
pkg of 25	

FILP-21403 CTN YCH	
48FBS Flush Bolt Strike Filler	
15/16" x 2 1/4" x 16 gage HRPO (2) # 8 CSK Zn Yellow Chromate or EZ Two (2) #8-32 FHMS	
pkg of 25	

FILP-80010 CTN YCH	
Door Edge Filler Plate	
For government 86 mortise 1 1/4" x 8" x 7 gage HRPO (2) # 12 CSK Zn Yellow Chromate or EZ Two(2) #12-24 FHMS	
pkg of 25	

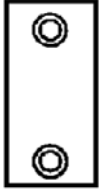
FILP-63400 CTN YCH	
48 FBF Flush Bolt Filler	
1" x 6 3/4" x 11 gage HRPO (2) # 8 CSK Zn Yellow Chromate or EZ Two (2) #8-32 FHMS	
pkg of 25	

DAYTON INDUSTRIES, INC.

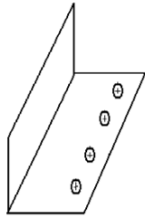
FLA-275 Z CTN	
Base Frame Weld In Anchor	
1 3/8" x 1 3/4" x 2 3/4" 16 gage Holes on one side for anchoring Zinc Plate	
pkg of 50	

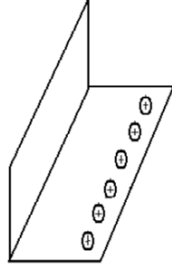
FLA-500 Z CTN	
Base Frame Weld In Anchor	
1 3/8" x 1 3/4" x 5" 16 gage Holes on one side for anchoring Zinc plate	
pkg of 50	

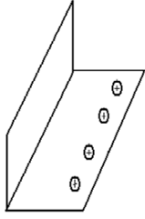
FLA-325 Z CTN	
Base Frame Weld In Anchor	
1 3/8" x 1 3/4" x 3 1/4" 16 gage Holes on one side for anchoring Zinc Plate	
pkg of 50	

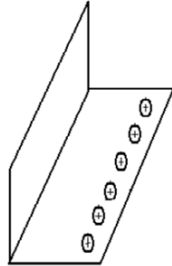
FLA-600 Z CTN	
Base Frame Weld In Anchor	
1 3/8" x 1 3/4" x 6" 16 gage Holes on one side for anchoring Zinc Plate	
pkg of 50	

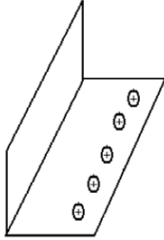
FLA-400 E CTN	
Base Frame Weld In Anchor	
1 3/8" x 1 3/4" x 4" 16 gage Holes on one side for anchoring Zinc Plate	
pkg of 50	

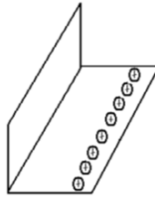
FLA-700 Z CTN	
Base Frame Weld In Anchor	
1 3/8" x 1 3/4" x 7" 16 gage Holes on one side for anchoring Zinc Plate	
pkg of 50	

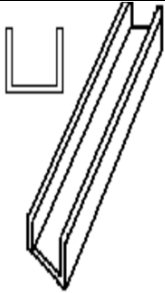
Glazing Bead	
GALVN No Holes 18 Gage	
GB-3', GB-4", GB-5" GB-6', GB-7", GB-8', GB-10' 5/8" x 5/8" x 5/8"	
50 pc bundle min	

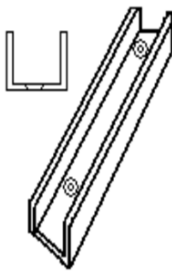
Glazing Bead 18 Gage	
GALVN with punched & Countersunk # 8 ; 6" from end 12" on center	
8' & 10' LENGTH ----- GBCS-8 5/8x5/8x5/8 GBCS-10-5/8x5/8x5/8	
50 pc bundle min	

FLA AST 1/8 X 2 X 83 1/8	
FLA AST 1/8 X 2 X 95 1/8	
FLAT ASTRAGAL (8-32) Counter Sunk .230" hole ELECTRO ZINC	
10 pc bundle min	

DAYTON INDUSTRIES, INC.

HFILL-45112 CTN YCH	
4 1/2" Door Hinge Filler Plate Two Zn Yellow Chromate or EZ For beveled edge (handed) doors. Two (2) #12-24 FHMS 1 1/2" x 4 1/2" x 10 gage HRPO (2) # 12 CSK pkg of 25	

HFILL-50134 CTN YCH	
5" Door Hinge Filler Plate Zn Yellow Chromate or EZ For square edge (handed) Two (2) #12-24 FHMS 1 3/4" x 5" x 10 gage HRPO (2) #12 CSK pkg of 25	

HFILL-45158 CTN YCH	
4 1/2" Door Hinge Filler Two (2) #12-24 FHMS Zn Yellow Chromate or EZ For 1 3/4" rabbeted frames 1 5/8" x 4 1/2" x 10 gage HRPO (2) # 12 CSK pkg of 25	

HFILL-50158 CTN YCH	
5" Door Hinge Filler Plate Zn Yellow Chromate or EZ For 1 3/4" rabbeted frames 1 5/8" x 5" x 10 gage HRPO (2) # 12 CSK Two (2) #12-24 FHMS pkg of 25	

HFILL-45134 CTN YCH	
4 1/2" Door Hinge Filler Plate 1" edge to C/L of CSK 1 3/4" x 4 1/2" x 10 gage HRPO Zn Yellow Chromate or EZ (2) # 12 CSK (handed) Two (2) #12-24 FHMS pkg of 25	

HRB125N07Z10C062	
1 1/4" x 10" x 7 gage Hinge Reinforcement No Tap Holes .062" offset Zn Plate or EZ pkg of 100	

HFILL-50112 CTN YCH	
5" Door Hinge Filler Plate Zn Yellow Chromate or EZ For beveled edge (handed) Two (2) #12-24 FHMS 1 1/2" x 5" x 10 gage HRPO (2) # 12 CSK pkg of 25	

DAYTON INDUSTRIES, INC.

HR45AYN07E10C062	
4.5" RW Hinge Reinforcement 1 1/4" x 10" x 7 gage EZ 4 holes tapped 12-24 fits doors & frames Accepts DC-TAB .062" offset pkg of 100	
HR45AYN07Z10E062	
pkg of 30	

HR5001N07E10C094	
5" HW Hinge Reinforcement 1 1/4" x 10" x 7 gage EZ 4 holes tapped 12-24 fits doors & frames Does NOT accept DC-TAB .094" offset Zn Plate or EZ pkg of 100	
HR5001N07E10D094	
pkg of 30	

HR45AYN07E10C094	
4.5" HW Hinge Reinforcement 1 1/4" x 10" x 7 gage EZ 4 holes tapped 12-24 fits doors & frames Accepts DC-TAB .094" offset pkg of 100	
HR45AYN07E10D094	
pkg of 30	

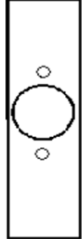
LKRF-16100 Z CTN	
# 161 Lock Reinforcement Zn Plated 1 1/4" x 4 1/2" x 7 gage 1 1/16" Dia Ctr Hole (2) 8-32 Thd	
pkg of 25	

HR45BJN07E10C094	
HINGE REINFORCEMENT 1 1/2" x 10" x 7 gage EZ 4 holes tapped 12-24 stand off projections that allow for Heavy & Regular Hinges Accepts DC-TAB pkg of 100 PCs	
HR45BJN07E10D094	
pkg of 30 PCs	

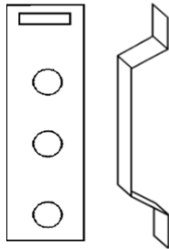
MA-1016E & YOKE-16E CTN	
Masonry Anchor & Yoke Weld yoke to frame 16 gage EZ pkg of 50	

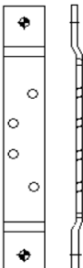
HR5001N07E10C062	
5" RW Hinge Reinforcement 1 1/4" x 10" x 7 gage HRPO 4 holes tapped 12-24 fits doors & frames Does NOT accept DC-TAB .062" offset Zn Plate or EZ pkg of 100	
HR5001N07E10D062	
pkg of 30	

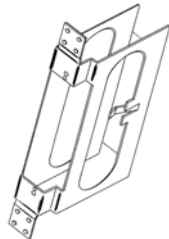
MORTISE LOCK BOX	
MLB-BV-P 1164 CTN	
MLB-BV-N 1164 CTN	
MLB-SQ-N 1164 CTN	
MLB-SQ-P 1164 CTN 14 gage EZ pkg of 5	

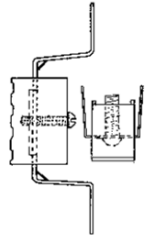
PCLP-1 CTN	
<p>Compression Clamp Assy Wood Stud Application 16 & 18 gage CRS</p> <p>pkg of 50</p>	

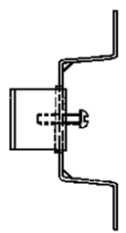
PCLP-3 CTN	
<p>Compression Clamp Assy Steel Stud application 16 gage CRS</p> <p>pkg of 50</p>	

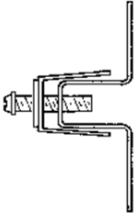
PCLP-2 CTN	
<p>Compression Clamp Assy Washer Hd screw locates and fills frame hole 16 & 18 gage CRS</p> <p>pkg of 50</p>	

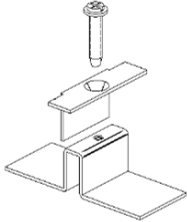
PCLP-NS CTN	
<p>Narrow Stop / Fits 5/8" Stop</p> <p>Compression Clamp Assy Washer Hd screw locates and fills frame hole 14 gage CRS</p> <p>pkg of 50</p>	

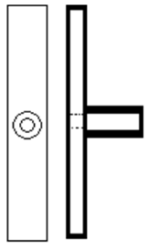
PIPE ANCHOR 434 EQ	
PIPE ANCHOR 534 EQ	
PIPE ANCHOR 534 UNEQ	
<p>Existing Wall Pipe Anchor Weld In Type Un-Equal Leg (UNEQ) or Equal Leg (EQ) 11 gage strap, 18 gage pipe 4 3/4" & 5 3/4"</p> <p>pkg of 100</p>	

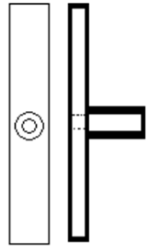
PIPE ANCHOR 634 EQ	
PIPE ANCHOR 734 EQ	
PIPE ANCHOR 834 EQ	
<p>Existing Wall Pipe Anchor Weld In Type Un-Equal Leg (UNEQ) or Equal Leg (EQ) 07 gage strap, 18 gage pipe 6 3/4", 7 3/4", 8 3/4"</p> <p>pkg of 100</p>	

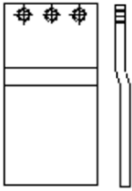
PT-01 E 125 CTN	
<p>Power Transfer Tab</p> <p>1 1/4" x 2 1/2" x 14 gage EZ Zinc Plate .125" offset (3) 10-32 THD</p> <p>pkg of 25</p>	

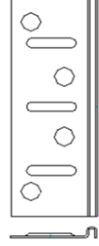
REVF-4520E RIBC	
<p>Reversible Door Hinge Filler</p> <p>20 gage EZ with Ribs</p> <p>pkg of 100</p>	

REVDRFILL-45134CYCH	
<p>4 1/2" Door Hinge Filler Two (2) #12-24 FHMS 1 3/16" edge to C/L of CSK For square edge (non-handed) doors. Zn yellow Chromate or EZ 1 3/4" x 4 1/2" x 10 gage HRPO (2) # 12 CSK</p> <p>pkg of 25</p>	

DAYTON INDUSTRIES, INC.

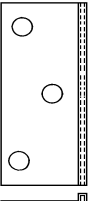
REVF-35 E CTN	
Reversible Door Hinge Filler	
25 gage EZ pkg of 100	

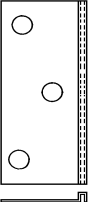
REVF-45 E CTN	
Reversible Door Hinge Filler	
25 gage EZ pkg of 300	

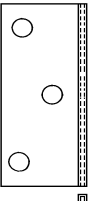
REVF-45 E LONG LEG CTN	
Reversible Door Hinge Filler WITH 1/4" LIP	
25 gage EZ pkg of 300	

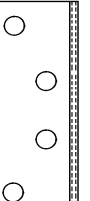
REVF-50 E CTN	
Reversible Door Hinge Filler	
25 gage EZ pkg of 100	

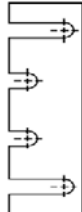
SHM-4516-SL E CTN	
Hinge Shim for 4 1/2" hinge EZ	
1 1/4" x 4 1/2" x .060" pkg of 50	

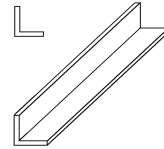
SPREADER BAR	
18 gage GALVN	
SB-3 (3/4 x 3/4 x 36)	
SB-4 (3/4 x 3/4 x 48)	
SB-5 (3/4 x 3/4 x 60)	
SB-6 (3/4 x 3/4 x 72)	
SB-7 (5/8 x 5/8 x 84)	
SB-8 (5/8 x 5/8 x 96)	
SB-10 (5/8 x 5/8 x 120)	
50 pc bundle	

SFILP-47800 CTN YCH	
Strike Filler Plate	
For ASA dead lock, strike no lip	
1 1/4" x 4 7/8" x 13 gage HRPO (2) # 12 CSK	
Zn Yellow Chromate or EZ Two (2) #12-24 FHMS pkg of 25	

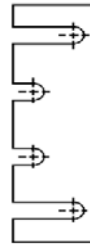
SHM-4522-SL E CTN	
Hinge Shim for 4 1/2" hinge EZ	
1 1/4" x 4 1/2" x .030" pkg of 50	

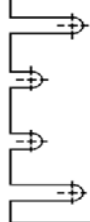
SHM-5016-SL E CTN	
Hinge Shim for 5" hinge EZ	
1 1/4" x 5" x .060" pkg of 50	

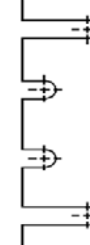
SHM-5022-SL E CTN	
Hinge Shim for 5" hinge EZ	
1 1/4" x 5" x .030" pkg of 50	

DAYTON INDUSTRIES, INC.

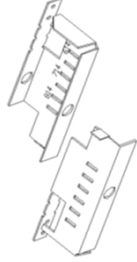
<p>SIA-ADJ 534-834C</p> <p>Snap In Adjustable Anchor 5 3/4" to 8 3/4" Jamb width 18 gage EZ</p> <p>Note: 2 PCs/set</p> <p>pkg of 50 sets</p>	
--	---

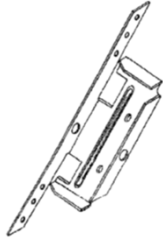
<p>SIA-LONG 834 CTN</p> <p>snap in anchor 8 3/4"</p> <p>8-3/4" jamb x 12 1/4" anchor 18 gage EZ</p> <p>pkg of 50</p>	
--	---

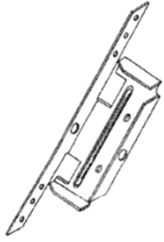
<p>SIA-LONG 534 CTN</p> <p>snap in anchor 5 3/4"</p> <p>5-3/4" jamb x 9 1/4" anchor 18 gage EZ</p> <p>pkg of 50</p>	
---	---

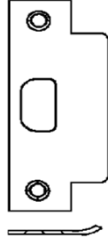
<p>SP-47812C CTN YCH CURVED LIP</p> <p>SP-47812S CTN YCH Straight</p> <p>ASA Strike CRS Zn Yellow Chromate or EZ 1 1/4" x 4 7/8" x 13 gage (2) # 12 CSK Two(2) #12-24 FHMS</p> <p>pkg of 25</p>	
---	---

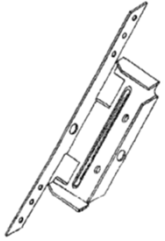
<p>SIA-LONG 634 CTN</p> <p>snap in anchor 6 3/4"</p> <p>6-3/4" jamb x 10 1/4" anchor 18 gage EZ</p> <p>pkg of 50</p>	
--	--

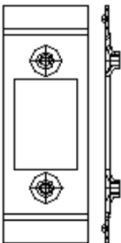
<p>SR-234 NP Z CTN</p> <p>One Piece Strike Reinforcement</p> <p>1 3/8" x 3 15/16" x 14 gage inside cutout 1 5/8" x 1"</p> <p>Zinc Plate (2) 8-32 THD</p> <p>pkg of 25</p>	
---	---

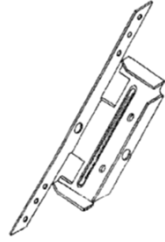
<p>SIA-LONG 734 CTN</p> <p>snap in anchor 7 3/4"</p> <p>7-3/4" jamb x 11 1/4" anchor 18 gage EZ</p> <p>pkg of 50</p>	
--	---

<p>SR-478 NP E CTN</p> <p>One Piece Strike Reinforcement</p> <p>1 5/8" x 7 5/8" x 14 gage inside cutout 1 5/32" x 3 1/2"</p> <p>EZ (2) 12-24 THD</p> <p>pkg of 25</p>	
---	---

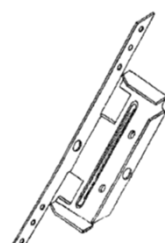
<p>SIA-LONG 814 CTN</p> <p>snap in anchor 8 1/4"</p> <p>8-1/4" jamb x 11 3/4" anchor 18 gage EZ</p> <p>pkg of 50</p>	
--	---

DAYTON INDUSTRIES, INC.

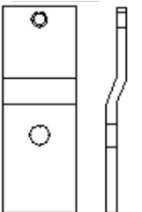
SR-01C12-24E062	
STRIKE REINFORCEMENT 1/16" offset. Zn Plated 1 1/8" x 2 1/2"x 11gage EZ 12-24 THD	

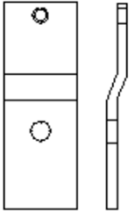
SR-02C12-24E062	
ASA Strike Tab Zn Plated For ASA strikes 1/16" offset. 7/8" x 2 1/2"x 11gage EZ 12-24 THD pkg of 50	

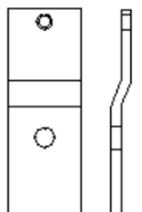
SR-01C12-24E141	
STRIKE REINFORCEMENT 9/64" offset. Zn Plated 1 1/8" x 2 1/2"x 11gage HRPO 12-24 THD	

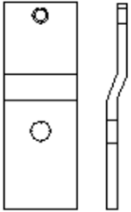
SR-02C12-24E125	
86 Lock Edge Tab For Government 86 locks 1/8" offset. Zn Plated 7/8" x 2 1/2"x 11gage EZ 12-24 THD pkg of 50	

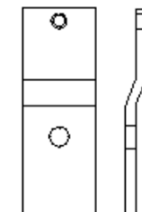
SR-02C08-32E062	
Dead Lock / Spring Lock Strike Tab For 160 & 161 latch bolts 1/16" offset. Zn Plated 7/8" x 2 1/2"x 11gage EZ 8-32 THD pkg of 50	

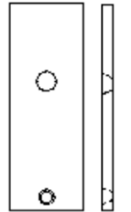
SR-02C12-24EFLA	
Strike Tab Zn Plated For strike in frame No offset 7/8" x 2 1/2" x 11 gage EZ 12-24 THD pkg of 50	

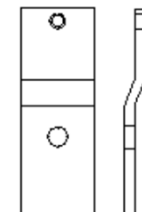
SR-02C08-32E094	
Dead Lock / Spring Latch Tab For 160 & 161 latch bolts 3/32" offset. Zn Plated 7/8" x 2 1/2"x 11gage EZ 8-32 THD pkg of 50	

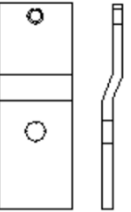
SR-02C12-24Z313	
Electric Strike Tab For Von Duprin, Folger Adams electric strikes 5/16" offset. Zn Plated 7/8" x 2 1/2"x 11gage HRPO 12-24 THD pkg of 50	

SR-02C08-32EFLA	
Flush Bolt Strike Tab Zn Plated For strike in header bars No offset 7/8" x 2 1/2" x 11 gage EZ 8-32 THD pkg of 50	

DAYTON INDUSTRIES, INC.

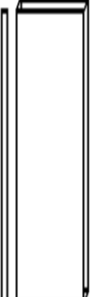
Weld In (WIR)	
Reinforcement	
HRP&O	
WIR 1 3/4-12-10GA	
1 3/4" x 12" x 10 gage pkg of 30 PCs	
WIR 1 3/4-16-10GA	
1 3/4" x 16" x 10 gage pkg of 30 PCs	
WIR 1 1/4-12-10GA	
1 1/4" x 12" x 10 gage pkg of 30 PCs	

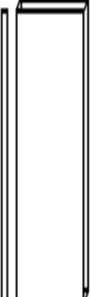
Weld In (WIR)	
Reinforcement Cont'd	
WIR 1 3/4-4-10GA	
1 3/4" x 4" x 10 gage pkg of 30 PCs	
WIR 3 1/4-18-16GA	
3" x 18" x 16 gage EZ pkg of 30 PCs	
WIR 7/8-12-16GA	
7/8" x 12" x 16 gage HRP&O pkg of 30 PCs	

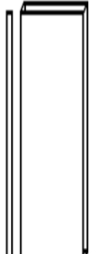
WIR 1 3/4-12-11GA E	
Weld-in Reinforcement	
1 3/4" x 12" x 11 gage pkg of 30 PCs	

Weld In (WIR)	
Reinforcement	
HRP&O	
WIR 1 1/2- 12-14GA	
1 1/2" x 12" x 14 gage	
WIR 1 1/2-10-14GA	
1 1/2" x 10" x 14 gage	

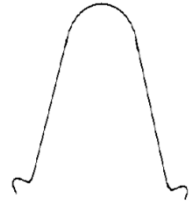
WMA-7 CTN	
Wire Masonary Anchor 7 gage pre-Galv	
6 PCs/bag 16 Bags (min order)	
bag of 6 PCs	

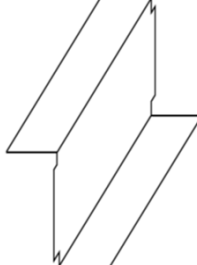
Z BAR Weld In EZ	
Z-158 E CTN 1 5/8" long	
Z-250 E CTN 2 1/2" long	
Z-358 E CTN 3 5/8" long	
pkg of 100	

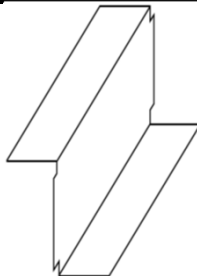
Z BAR Weld In	
Z-158 CTN 1 5/8" long	
Z-250 CTN 2 1/2" long	
Z-358 CTN 3 5/8" long	
pkg of 100	